

## 深圳市晶科鑫实业有限公司

### 样品承认书

客户代码:	
物料名称:	贴片钟振
规格型号:	SMD7050 OSC 50.000MHZ 1.8~3.3V ±10PPM LVCMOS -40~85°C
P N/ SJK:	6N50000G33YC
环保属性:	<input checked="" type="checkbox"/> RoHS <input checked="" type="checkbox"/> REACH <input checked="" type="checkbox"/> HF <input type="checkbox"/> PAHS <input type="checkbox"/> 其它
版 次:	A1    2017-5-10 初版
湿敏等级:	一级

承 认 签 章					
供 应 商 承 认			( ) 公 司 承 认		
制 定	审 核	核 准	工 程 师	审 核	批 准
贺丹斌		黄灏东			
SJK 支持	18682088994 (Mr.黄)		盖章签署		
FAE_EMAIL	<a href="mailto:sjk-fae@q-crystal.com">sjk-fae@q-crystal.com</a>		日 期		
日 期					
备注:					

# CRYSTAL OSCILLATOR

**SERIES 6N, SEAM SEALED CERAMIC 7.0X5.0MM SURFACE MOUNT PACKAGE**

## 1. ELECTRICAL SPECIFICATIONS

### Standard atmospheric conditions

Unless otherwise specified, the standard range of atmospheric conditions for making measurement and tests are as follow:

Ambient temperature : 25±5°C

Relative humidity : 40%~70%

If there is any doubt about the results, measurement shall be made within the following limits:

Ambient temperature : 25±3°C

Relative humidity : 40%~70%

### Measure equipment

Electrical characteristics measured by MD 37WX-05M or equivalent.

### Crystal cutting type

The crystal is using AT CUT (thickness shear mode).

	Parameters	SYM	Electrical Spec.				Notes
			MIN	TYPE	MAX	UNITS	
1	Nominal Frequency		50.000000			MHZ	
2	Frequency Stability	AT 25°C	±10			PPM	
		Over Operating Temperature range	±20			PPM	-40~85°C
3	Operating Temperature	Topr	-40	25	85	°C	
4	Storage Temperature	Tstg	-55	~	125	°C	
5	Supply Voltage	VDD	1.8~3.3 / ±10%			V	1.62~3.63 available
6	Input Current	Icc			10	mA	
7	Enable Control		Yes				Pad1
8	Output Load : CMOS	CL	15			pF	
9	Output Voltage High	VoH	90% Vdd			V	
10	Output Voltage Low	VoL			10% Vdd	V	
11	Rise Time	Tr			5	ns	10%→90%VDD Level
12	Fall Time	Tf			5	ns	90%→10%VDD Level
13	Symmetry (Duty ratio)	TH/T	45	~	55	%	
14	Start-up Time	Tosc			10	ms	
15	Enable Voltage High	Vhi	70% Vdd			V	
16	Disable Voltage Low	Vlo			30% Vdd	V	
17	Aging		±3			ppm/yr.	1st. Year at 25°C
18	Output Disable Delay Time	T off			150	us	
19	Output Enable Delay Time	T on			150	us	
20	Phase Jitter (12KHZ~20MHZ)			0.5	1.0	ps	

电话: 0755-88352810-837(Mr.huang) 传真: 0755-88353718 <http://www.q-crystal.com>

公司地址: 深圳市龙岗区天安云谷产业园一期 3 栋 C 座 12 楼 1204~1206 室

# CRYSTAL OSCILLATOR

**SERIES 6N, SEAM SEALED CERAMIC 7.0X5.0MM SURFACE MOUNT PACKAGE**

## 2. DIMENSIONS (Units :mm)

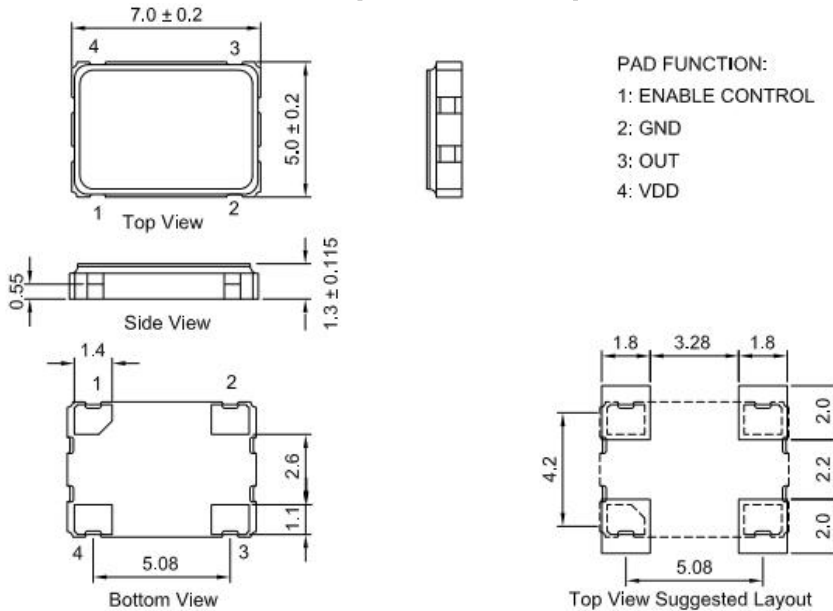

## 3. MARKING

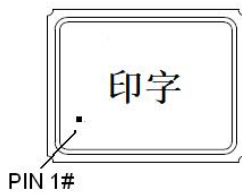

## 4. TEST CIRCUIT

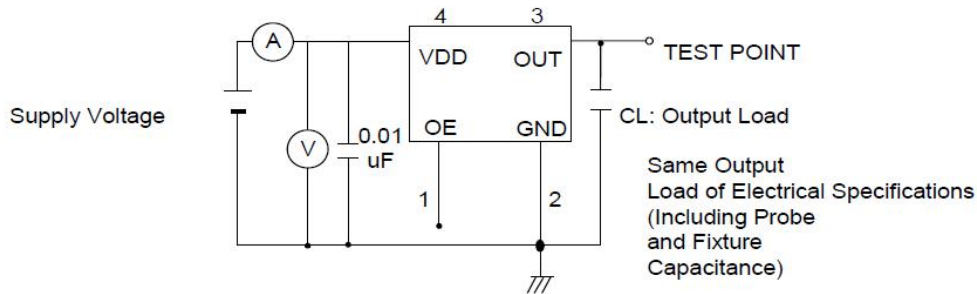

Control input (output enable/disable)  
Logic 1 or open on pad 1:  
Oscillator output  
Logic 0 on pad 1 : Disable output to high impedance

## 5. WAVEFORM CONDITIONS

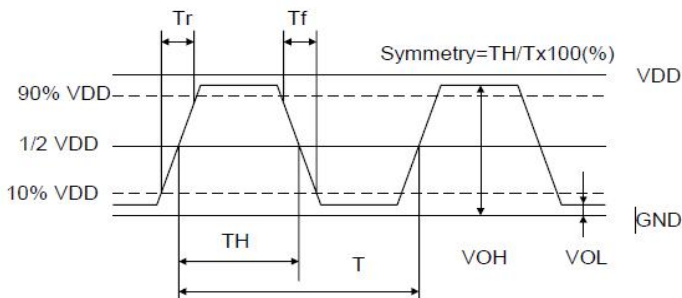

Waveform measurement system should have a min. bandwidth of 5 times the frequency being tested.

# CRYSTAL OSCILLATOR

**SERIES 6N, SEAM SEALED CERAMIC 7.0X5.0MM SURFACE MOUNT PACKAGE**

## 6. OUTPUT ENABLE / DISABLE DELAY

The following figure shows the oscillator timing during normal operation. Note that when the device is in standby, the oscillator stops. When standby is released, the oscillator starts and stable oscillator output occurs after a short delay

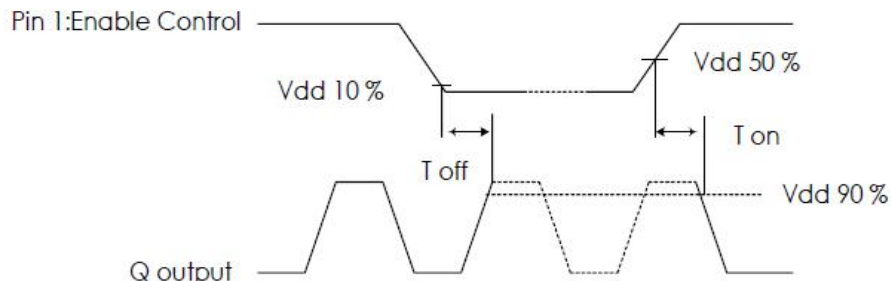

## 7. SUGGESTED REFLOW PROFILE

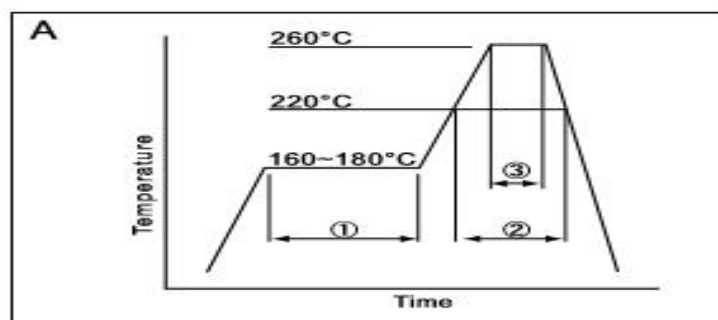

①	Preheat	160~180°C	120sec.
②	Primary heat	220°C	60sec.
③	Peak	260°C	10sec. max

Total time : 200 sec. Max / Solder melting point :220 °C

## 8. STRUCTURE ILLUSTRATION

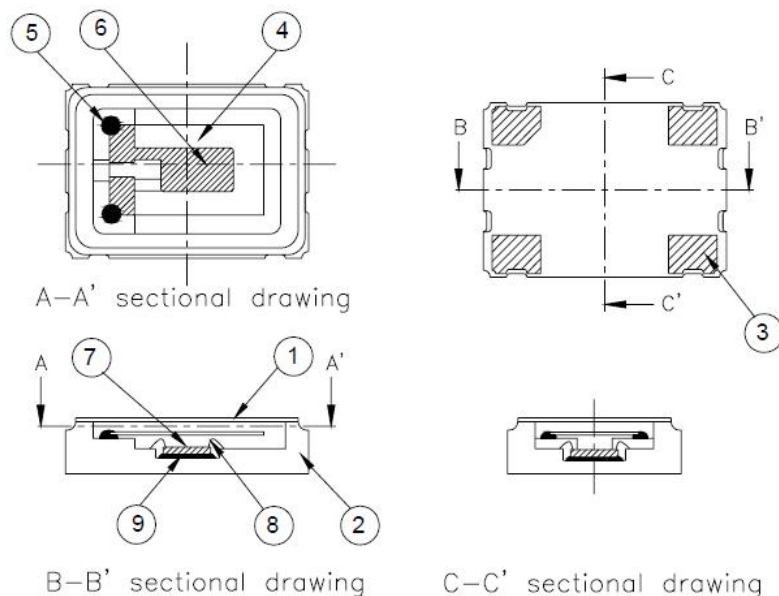



# CRYSTAL OSCILLATOR

## SERIES 6N, SEAM SEALED CERAMIC 7.0X5.0MM SURFACE MOUNT PACKAGE

NO	COMPONENTS	MATERIALS	FINISH/SPECIFICATIONS
1	LID	Kovar (Fe/Co/Ni)	
2	Base(Package)	Ceramic (Al <sub>2</sub> O <sub>3</sub> ) + Kovar (Fe/Co/Ni)+ Ag/Cu	Color black
3	PAD	Au	Tungsten metalize + Ni plating + Au plating
4	Crystal blank	SiO <sub>2</sub>	
5	Conductive adhesive	Ag	Silicon resin
6	Electrode	Noble Metal	
7	IC chip		
8	Bonding wire	Au	Pad 1 options : NC is 5 wires , EN is 6 wires.
9	Die attached	Conductive (Ag)	Epoxy resin

## 9. RELIABILITY TEST SPECIFICATION

### 1.Mechanical Endurance

No.	Test Item	Test Methods	REF. DOC
1	Drop Test	75 cm height,3 times on concrete floor .	JIS C6701
2	Mechanical Shock	Device are shocked to half sine wave ( 1000 G ) three mutually perpendicular axes each 3 times. 0.5m sec. duration time	MIL-STD-202F
3	Vibration	Frequency range 10 ~ 2000 Hz Amplitude 1.52 mm/20G Sweep time 20 minutes Perpendicular axes each test time 4 Hrs (Total test time 12 Hrs)	MIL-STD-883E
4	Gross Leak	Standard Sample For Automatic Gross Leak Detector, Test Pressure: 2kg / cm <sup>2</sup>	MIL-STD-883E
5	Fine Leak	Helium Bomging 4.5 kgf / cm <sup>2</sup> for 2 Hrs	
6	Solderability	Temperature 245 °C ± 5°C Immersing depth 0.5 mm minimum Immersion time 5 ± 1 seconds Flux Rosin resin methyl alcohol solvent ( 1 : 4 )	MIL-STD-883E

### 2.Environmental Endurance

No.	Test Item	Test Methods	REF. DOC
1	Resistance To Soldering Heat	Pre-heat temperature 125 °C Pre-heat time 60 ~ 120 sec. Test temperature 260 ± 5 °C	MIL-STD-202F

电话: 0755-88352810-837(Mr.huang) 传真: 0755-88353718 <http://www.q-crystal.com>  
公司地址: 深圳市龙岗区天安云谷产业园一期 3 栋 C 座 12 楼 1204~1206 室



# CRYSTAL OSCILLATOR

## SERIES 6N, SEAM SEALED CERAMIC 7.0X5.0MM SURFACE MOUNT PACKAGE

		Test time 10 ± 1 sec.	
2	High Temp. Storage	+ 125 °C ± 3 °C for 1000 ± 12 Hrs	MIL-STD-883E
3	Low Temp. Storage	- 40 °C ± 3 °C for 1000 ± 12 Hrs	
4	Thermal Shock	Total 100 cycles of the following temperature cycle 	MIL-STD-883E
5	Pressure Cooker Storage	121 ± 3 °C , RH100% , 2 bar , 240 Hrs	JIS C6701
6	High Temp & Humidity	85 °C ± 3 °C, RH 85% , 1000 Hrs	JIS C5023

备注

SPXO / OSC系列							
SJK-	3N	12000/or12000A	-	E	33	Y	C
	封装	中心频率(MHZ)		频率精度	工作电压 (V)	输出模式	工作温度
例	3N:3225	12000:		A: ±5PPM	18: 1.8V	Y:LVC MOS	A: -10~60
	2N:2520	12.000MHZ		B: ±15PPM	25: 2.5V	S:SINCE	B: -20~70
	1N:2016	12000A:		C: ±25PPM	33: 3.3V		C: -40~85
	7N:5032	12.000***MHZ		D: ±50PPM	50: 5.0V		D: -20~105
	6N:7050	(A代表小数量最后4~6位数值)		E: ±10PPM			E: -20~85
	3NM:3225 PROG			F: ±20PPM			F: -30~85
	2NM:2520 PROG			G: ±30PPM			G: -40~105
	1NM:2016 PROG			H: ±100PPM			H: -40~125
	7NP:5032 PROG			S: Spec			S: Spec
	6NP:7050 PROG						
	3NP:3225 PROG						
	2NP:2520 PROG						
	1NP:2016 PROG						
	7NP:5032 PROG						
6NP:7050 PROG							

电话: 0755-88352810-837(Mr.huang) 传真: 0755-88353718 <http://www.q-crystal.com>  
 公司地址: 深圳市龙岗区天安云谷产业园一期 3 栋 C 座 12 楼 1204~1206 室

单击下面可查看定价，库存，交付和生命周期等信息

[>>SJK\(晶科鑫\)](#)